

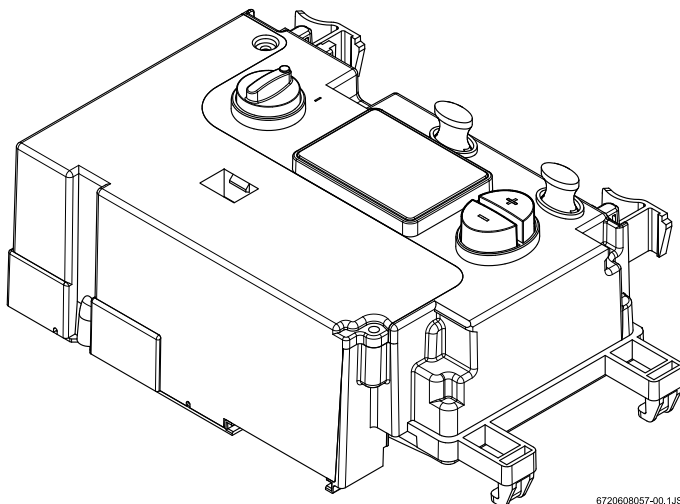

**Control box / Tableau électrique / Scheda elettronica
Schaltkasten / Caja de mando electrónica / Caixa de comando**

8 707 207 112 0 / 8 707 207 163 0



6720608057-00.1JS

1 Control box



Once control box replaced, it must be selected the gas type for which the appliance will work with.

GPL

- ▶ Press the programming key and set the main switch in position I.

The LCD displays the signal "P1".

- ▶ Press the key , until the signal "P5" appears.
- ▶ Keep programming key pressed until LCD displays signal "o3".

Natural Gas

- ▶ Press the programming key and set the main switch in position I.

The LCD displays the signal "P1".

- ▶ Press the key , until the signal "P6" appears.
- ▶ Keep programming key pressed until LCD displays signal "o2".

1 Tableau électrique



Après avoir substitué le boîtier de commande, le type de gaz avec lequel l'appareil va travailler doit être sélectionné.

Butane/Propane

- ▶ Appuyer sur la touche de programmation et simultanément placer l'interrupteur principal en position 1.

Le tableau LCD affiche l'indication "P1".

- ▶ Appuyer sur la touche , jusqu'à l'apparition de l'indication "P5".

- ▶ Maintenir enfoncée la touche de programmation jusqu'à ce que l'indication « o3 » s'affiche dans le tableau LCD.

Gaz Naturel

- ▶ Appuyer sur la touche de programmation et simultanément placer l'interrupteur principal en position 1.

Le tableau LCD affiche l'indication "P1".

- ▶ Appuyer sur la touche , jusqu'à l'apparition de l'indication "P6".
- ▶ Maintenir enfoncée la touche de programmation jusqu'à ce que l'indication « o2 » s'affiche dans le tableau LCD.



1 Schedda elettronica



Una volta che la schedda elettronica sostituita, esso deve essere selezionata il tipo del gas per cui l'apparecchio funzionerà con.



Gas GPL

- ▶ Interruttore principale in posizione 0.
- ▶ Tener premuto il tasto "Program".
- ▶ Ruotare l'interruttore principale in posizione I. Il display visualizza il codice "P1".

- ▶ Rilasciare il tasto "Program" e premere il tasto , fino a far visualizzare il codice "P5".
- ▶ Premere di nuovo il tasto "Program", rilasciarlo e premere il tasto , fino a far visualizzare la cifra "o3".

Gas Metano

- ▶ Interruttore principale in posizione.
- ▶ Tener premuto il tasto "Program".
- ▶ Ruotare l'interruttore principale in posizione I. Il display visualizza il codice "P1".

- ▶ Rilasciare il tasto "Program" e premere il tasto , fino a far visualizzare il codice "P6".
- ▶ Premere di nuovo il tasto "Program", rilasciarlo e premere il tasto  fino a far visualizzare la cifra "o2".

1 Schaltkasten



Wenn der Schaltkasten ersetzt wird, muss der Gastyp mit dem das Gerät arbeiten wird gewählt werden.

Flüssiggas

- ▶ Die Programmtaste drücken und den Hauptschalter auf Position I legen.

Im LCD Display erscheint "P1".

- ▶ Die Taste , drücken bis "P5" erscheint.
- ▶ Die Programmtaste drücken bis im LCD Display "o3" erscheint.

Erdgas

- ▶ Die Programmtaste drücken und den Hauptschalter auf Position I legen.

Im LCD Display erscheint "P1".

- ▶ Die Taste , drücken bis "P6" erscheint.
- ▶ Die Programmtaste drücken bis im LCD Display "o2" erscheint.

1 Caja de mando electrónica



Una vez sustituida la caja de mando electrónica, debe ser seleccionado el tipo de gas para el cual trabajará el aparato.

GPL

- ▶ Pulse la tecla de programación, coloque el interruptor principal en la posición I.

El display de LCD indica "P1".

- ▶ Pulse la tecla  hasta que aparezca la indicación "P5".
- ▶ Mantenga pulsada la tecla de programación hasta que en el display de LCD aparezca la indicación "o3".

Gas Natural

- ▶ Pulse la tecla de programación, coloque el interruptor principal en la posición I.

El display de LCD indica "P1".

- ▶ Pulse la tecla  hasta que aparezca la indicación "P6".
- ▶ Mantenga pulsada la tecla de programación hasta que en el display de LCD aparezca la indicación "o2".

1 Caixa de comando



Uma vez substituída a caixa de comando, deve ser selecionado o tipo de gás com o qual o aparelho vai funcionar.

GPL

- ▶ Pressionar a tecla de programação e colocar o interruptor principal na posição I.

O painel LCD mostra a indicação "P1".

- ▶ Pressionar a tecla , até surgir a indicação "P5".
- ▶ Manter pressionada a tecla de programação até surgir no painel LCD a indicação "o3".

Gás Natural

- ▶ Pressionar a tecla de programação e colocar o interruptor principal na posição I.

O painel LCD mostra a indicação "P1".

- ▶ Pressionar a tecla , até surgir a indicação "P6".
- ▶ Manter pressionada a tecla de programação até surgir no painel LCD a indicação "o2".

